



European Technical Assessment

ETA 15/0913
of 24.12.2015



General part

Trade name of the construction product	CONLIT[®] MC & CONLIT[®] FP
Product family to which the construction product belongs	Fire stopping and fire sealing products
Manufacturer	ROCKWOOL PENINSULAR SAU Polígono Industrial de Caparroso Ctra. Nacional 121, km 53,5 ES-31380 Caparroso (Navarra) Spain
Manufacturing plant(s)	According to Annex N kept by ITeC
This European Technical Assessment contains	17 pages including 3 Annexes which form an integral part of this assessment and Annex N, which contains confidential information and is not included in the European Technical Assessment when that assessment is publicly available
This European Technical Assessment is issued in accordance with Regulation (EU) 305/2011, on the basis of	ETAG 026, Part 1 edition September 2012 and Part 3 edition August 2011, used as European Assessment Document (EAD)

General comments

Translations of this European Technical Assessment in other languages shall fully correspond to the original issued document.

Communication of this European Technical Assessment, including transmission by electronic means, shall be in full (excepted the confidential Annex(es)).

Specific parts of the European Technical Assessment

1 Technical description of the product

CONLIT® MC and CONLIT® FP systems are composed of CONLIT® 150 P slabs and additional components for their installation.

CONLIT® 150 P is a fire protective slab made of mineral wool impregnated with a synthetic binder, with no covering. Characteristics of the slabs are given in Table 1.

Table 1: Dimensions and density of CONLIT® 150 P.

Characteristic	Nominal value	Tolerance
Density (kg/m ³) at 23°C, 50% RH	180	± 9 %
Length (mm)	1800	± 3
Width (mm)	1200	± 3
Thickness (mm)	50	-1/+3

CONLIT® 150 P slabs are also covered by ETA 09/0275 for its intended use as fire protection of load-bearing steel elements.

Assembled systems require additional components as described in Annex 2 and Annex 3 of this ETA. These components are not covered by this ETA and cannot be CE marked on its basis.

2 Specification of the intended use(s) in accordance with the applicable EAD

CONLIT® MC is a system intended to seal the gap between the concrete floor and the curtain walling, as described in Annex 2, in order to provide the fire resistance performance.

CONLIT® FP is a system intended to seal the perimeter between the concrete floor and the curtain walling, as described in Annex 3, in order to provide the fire resistance performance.

Regarding the environmental conditions, CONLIT® MC and CONLIT® FP are intended for use category Type Z₂, defined as internal conditions with humidity lower than 85 % RH, excluding temperatures below 0°C, in accordance with ETAG 026-3, section 1.2.

The provisions made in this ETA are based on a working life of CONLIT® MC and CONLIT® FP systems of at least 25 years, provided that the conditions laid down in the manufacturer's instructions for the installation, use and maintenance are met. These provisions are based upon the current state of the art and the available knowledge and experience.

The indications given as to the working life cannot be interpreted as a guarantee, but are regarded only as a means for choosing the appropriate products in relation to the expected economically reasonable working life of the works.

3 Performance of the product and reference to the methods used for its assessment

3.1 Performance of the product

The assessment of CONLIT® MC and CONLIT® FP for the intended use considering the basic requirements for construction works 2, 3 and 6 was performed following the ETAG 026 for *Fire Stopping and Fire Sealing Products, Part 1: General (September 2012) and Part 3: Linear Joint and Gap Seals (August 2011)*, used as EAD.

Table 2: Performance of the product.

Product: CONLIT® MC & CONLIT® FP		Intended use: Fire Stopping and Fire Sealing Products
Basic requirement	Essential characteristic	Performance
BWR 2 Safety in case of fire	Reaction to fire	A1
	Resistance to fire	See Annex 1, 2 and 3
BWR 3 Hygiene, health and the environment	Release of dangerous substances	See 3.2.3
BWR 6 Energy economy and heat retention	Thermal conductivity, $\lambda_{U,90/90(23/50)}$	0,035 W/m-K
General aspects relating to the performance of the product	Durability	Type Z ₂

3.2 Methods used for the assessment

3.2.1 Reaction to fire

The performance of CONLIT® 150 P slab has been tested according to EN ISO 1182¹ and EN ISO 1716² and determined according to EN 13501-1³.

Additional components made of steel, as described in Annex 2 and Annex 3, have a class A1 according to Decision 96/603/EC and Decision 2000/605/EC.

3.2.2 Fire resistance

Tested and assessed according to EN 1364-4⁴, the fire resistance classification has been defined according to EN 13501-2⁵ and is given in Annex 1.

¹ EN ISO 1182:2010. *Reaction to fire tests for products. Non-combustibility test.*

² EN ISO 1716:2010. *Reaction to fire tests for products. Determination of the gross heat of combustion (calorific value).*

³ EN 13501-1:2007+A1:2009. *Fire classification of construction products and building elements. Part 1: Classification using data from reaction to fire tests.*

⁴ EN 1364-4:2007. *Fire resistance tests for non-loadbearing elements. Part 4: Curtain walling - Part configuration.*

⁵ EN 13501-2:2007+A1:2009. *Fire classification of construction products and building elements. Part 2: Classification using data from fire resistance tests, excluding ventilation services.*

3.2.3 Release of dangerous substances

According to the manufacturer's declaration, the specification of CONLIT® 150 P has been compared with the dangerous substances listed on EOTA Technical Report 034⁶, with Annex VI to Regulation (EC) No 1272/2008 and with the *Indicative list of regulated dangerous substances possibly associated with construction products under the CPD, DS 041/051 Rev.12, 22 March 2012* of the EC Experts Group to verify that the slabs do not contain such substances, with the exception of formaldehyde and manmade mineral wool fibres as indicated below.

- Formaldehyde: content < 0,0105 mg/m³ (manufacturer's declared value, calculated from slab composition)
- Mineral wool fibres meet the requirements given in Note Q of the Regulation (EC) 1272/2008 and are therefore not potentially carcinogenic⁷

In addition to the specific clauses relating to dangerous substances contained in this ETA, there may be other requirements applicable to the products falling within its scope. In order to meet the provisions of the EU Construction Products Regulation, these requirements need also be complied with, when and where they apply.

3.2.4 Thermal insulation

Thermal conductivity has been tested according to EN 12667⁸ and EN 13162⁹.

Table 3: Thermal characteristics.

$\lambda_{10,dry}$	0,034	(W/m·K)	Mean test result at 10 °C and dry conditions
$\lambda_{10,dry,90/90}$	0,035	(W/m·K)	Conductivity fractile value at 10 °C and dry conditions, representing at least 90 % of the production with a confidence level of 90 %
$\lambda_{U,90/90(23/50)}$	0,035	(W/m·K)	Design value of conductivity at 23 °C and 50 % RH

3.2.5 General aspects relating to the performance of the product

Mineral wool CONLIT® 150 P slabs are intended for environmental use category Type Z₂ in accordance with ETAG 026-3 and EN 13162. Additionally, dimensional stability of CONLIT® 150 P slabs has been tested according to EN 1604¹⁰ at (70 ± 2) °C / (90 ± 5) % RH and the slabs are designated as DS(70,90) in accordance with EN 13162 ($\Delta\epsilon \leq 1\%$).

Additional metallic components for system installation are intended for environmental use category Type Z₂ (internal conditions) according to the coating specification for corrosion protection as given in Annex 2 and Annex 3.

The ETA is issued for the systems on the basis of agreed data/information, deposited with the ITeC, in accordance with ETAG 026-3, section 5.

⁶ TR 034 *General ER 3 Checklist for ETAGs/CUAPs/ETAs-Content and/or release of dangerous substances in products/kits*, Edition March 2012.

⁷ The manufacturer is member of EUCEB (European Certification Board for Mineral Wool Products) and mineral wool used for CONLIT® 150 P has the EUCEB's certificates.

⁸ EN 12667:2001 *Thermal performance of building materials and products. Determination of thermal resistance by means of guarded hot plate and heat flow meter methods. Products of high and medium thermal resistance.*

⁹ EN 13162:2012 *Thermal insulation products for buildings. Factory made mineral wool (MW) products – Specification.*

¹⁰ EN 1604:1996 *Thermal insulating products for building applications - Determination of dimensional stability under specified temperature and humidity conditions*

4 Assessment and verification of constancy of performance (AVCP) system applied, with reference to its legal base

According to the Decision 1999/454/EC of the European Commission, the system of AVCP (see EC delegated Regulation (EU) No 568/2014 amending Annex V to Regulation (EU) 305/2011) given in the following table applies.

Table 4: AVCP System.

Product(s)	Intended use(s)	Level(s) or class(es)	System(s)
Fire stopping and fire sealing products	For fire compartmentation and/or fire protection or fire performance	Any	1

5 Technical details necessary for the implementation of the AVCP system, as foreseen in the applicable EAD

All the necessary technical details for the implementation of the AVCP system are laid down in the *Control Plan* deposited with the ITeC.

The *Control Plan* is a confidential part of the ETA and only handed over to the notified product certification body involved in the assessment and verification of constancy of performance.

The factory production control operated by the manufacturer shall be in accordance with the above mentioned *Control Plan*.

Issued in Barcelona on 24 December 2015

by the Catalonia Institute of Construction Technology.



Ferran Bermejo Nualart
Technical Director, ITeC

ANNEX 1. Resistance to fire performance

A.1.1 Classification

Resistance to fire classification of CONLIT® MC and CONLIT® FP in function of the fire exposure (internal / internal and external) is given in Table A.1.1.

Table A.1.1: Fire stopping systems and performance.

System	Classification according to EN 13501-2	Installation details
CONLIT® MC	EI 120 (i→o)	Annex 2
	E 60 (i↔o)	
CONLIT® FP	EI 120 (i→o)	Annex 3
	E 60 (i↔o)	
	EI 45 (i↔o)	

A.1.2 Classification of system CONLIT® MC

The assembly described in Annex 2 has been tested and assessed according to EN 1364-4 and classified in accordance with EN 13501-2.

Tests were carried out for standard configuration 1 (internal fire exposure) and 13 (internal and external fire exposure) according to EN 1364-4.

The maximum duration of the exposure to the standard time - temperature curve defined in EN 1363-1, clause 5.1.1, was 126 minutes (standard configuration 1) and 69 minutes (standard configuration 13). The spandrel panels remained in place over its full height during the test.

A.1.3 Classification of system CONLIT® FP

The assembly described in Annex 3 has been tested and assessed according to EN 1364-4 and classified in accordance with EN 13501-2.

Tests were carried out for standard configuration 1 (internal fire exposure) and 13 (internal and external fire exposure) according to EN 1364-4.

The maximum duration of the exposure to the standard time - temperature curve defined in EN 1363-1, clause 5.1.1, was 128 minutes (standard configuration 1) and 74 minutes (standard configuration 13). The spandrel panels remained in place over its full height during the test.

ANNEX 2. Installation of CONLIT® MC system related to resistance to fire performance

A.2.1. General

System CONLIT® MC shall be installed as described in this Annex to meet the resistance to fire classification given in Table A.1.1.

The components of CONLIT® MC system shall be those given in Table A.2.2 and design provisions be in accordance with Figure A.2.2 and A.2.3.

A.2.2. Supporting structure

The supporting structure is a reinforced concrete floor with a thickness of at least 200 mm and a density of at least 2000 kg/m³. The tested floor was 3 m length and 1 m width.

A.2.3. Framing system

The framing system for the curtain wall is made of AW6063 T5 anodised aluminium mullions and transoms of rectangular hollow section (130 mm depth x 52 mm width x 2,3 mm thickness). Connection between mullions and transoms is made by using a hidden fastening system. Inner dimensions of one single frame are of 1000 mm height and 1450 mm length. Profile dimensions and distance between mullions and transoms can be modified in accordance with EN 1364-4.

Framing system is attached to the floor through the mullions, which are fixed with self-tapping screws to an angle brace, which in turn is fixed with anchor bolts to the upper side of floor (see Table A.2.1 and Figures A.2.1 and A.2.4).

Table A.2.1: Components of the framing system fixing to the floor.

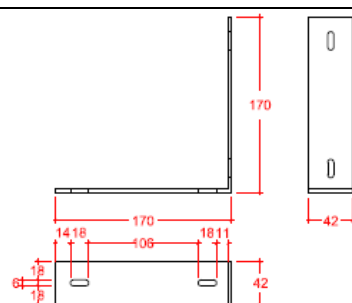

Component	Characteristics
Angle brace	Hot-rolled iron Dimensions: (170 x 170 x 42 x 3) mm
Self-tapping screw	Stainless steel Length: 25 mm; Ø 5,5 mm
Metal expansion anchor	Self-tapping screw and sleeve of galvanised steel (5 µm zinc) d ₀ = 8 mm; h ₁ = 60 mm Tension strength in C20/25 concrete: 9 kN Shear strength in C20/25 concrete: 7 kN



A.2.4. CONLIT® MC system

CONLIT® MC system consists of the components specified in next table.

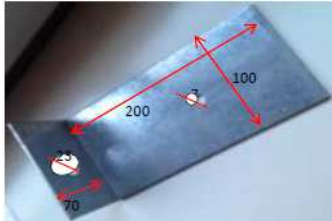
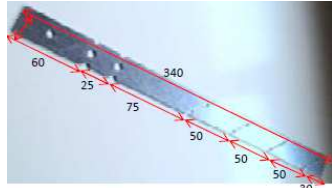
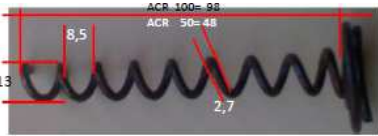
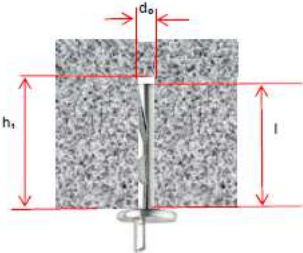
Table A.2.2: Components of the system CONLIT® MC.

Component	Characteristics	
CONLIT® 150 P	See Table 1.	
Angle brace CONLIT® MC	Galvanised steel DX51D+Z275 Dimensions: (70+200) x 100 x 3 mm	
Blade CONLIT® MC	Galvanised steel DX51D+Z275 Dimensions: (340 x 25 x 1) mm	
Screw CONLIT® ACR 50	Phosphate steel SL (zinc 8 µm to 12 µm) according to EN 10270-1 ¹¹ Length: 50 mm; Ø 13 mm	
Screw CONLIT® ACR 100	Phosphate steel SL (zinc 8 µm to 12 µm) according to EN 10270-1 Length: 100 mm; Ø 13 mm	
Anchor CONLIT® MC (ANCU 0635)	Steel grade 4,8 (body) and 8,8 (wedge) $d_0 = 6$ mm; $h_1 = 45$ mm; $l = 40$ mm Tension strength in C20/25 concrete: 1,89 kN	
Metal expansion anchor	Self-tapping screw and sleeve of galvanised steel (5 µm zinc) $d_0 = 8$ mm; $h_1 = 40$ mm Tension strength in C20/25 concrete: 5 kN Shear strength in C20/25 concrete: 7 kN	
Intumescent mastic	Acrylic resin EI 120 when tested as linear joint seal according to EN 1366-4 ¹²	

¹¹ EN 10270-1:2011. *Steel wire for mechanical springs. Part 1: Patented cold drawn unalloyed spring steel wire.*

¹² EN 1366-4:2006. *Fire resistance tests for service installations. Part 4: Linear joint seals.*

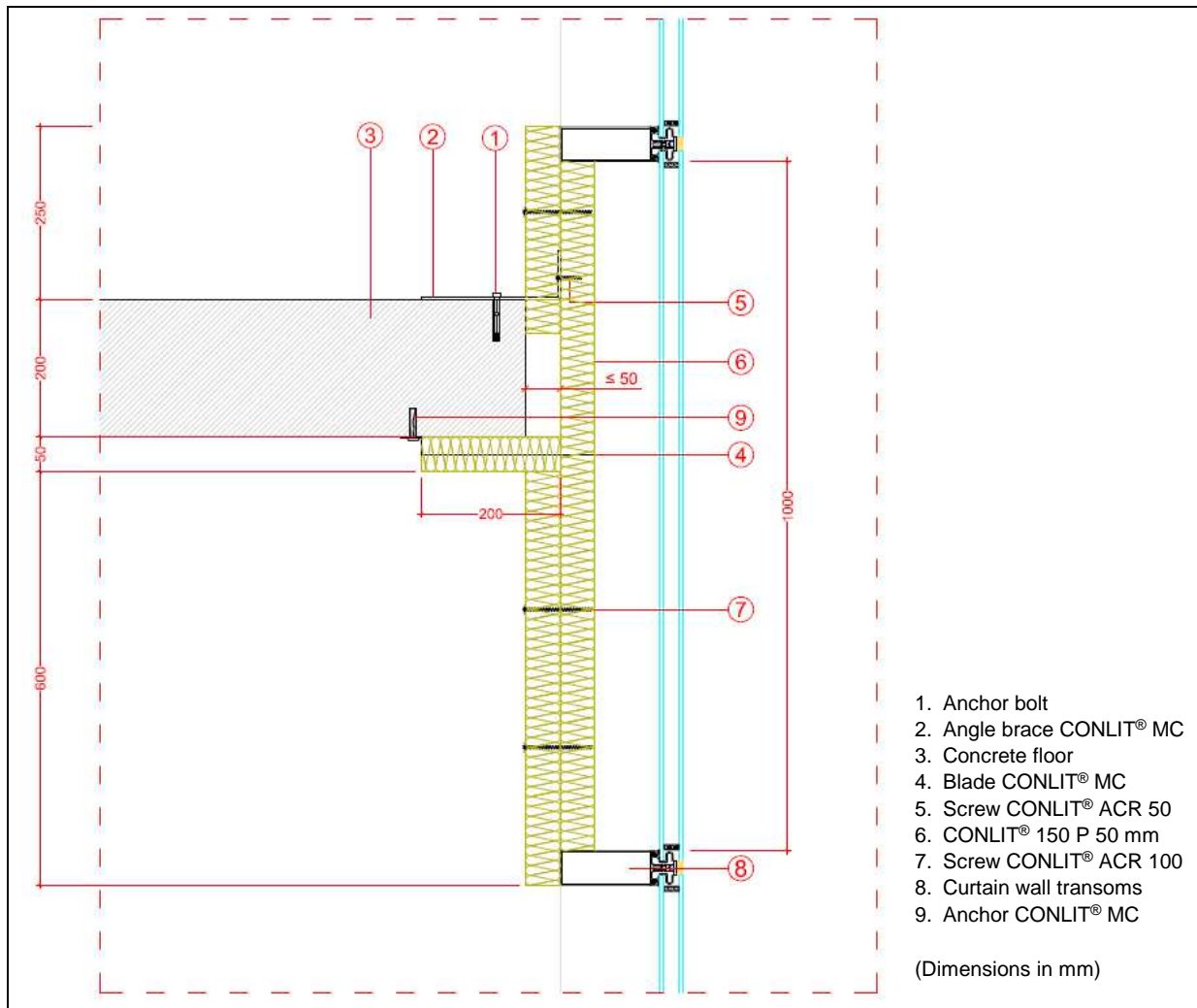
Figure A.2.1: Vertical section of installed CONLIT® MC system.

Angle braces CONLIT® MC are fixed on top of the floor with anchor bolts at a maximum distance of 500 mm centres. CONLIT® 150 P slabs, fitted into the aluminium frame of the curtain wall, are fixed to the braces with screws CONLIT® ACR 50 (see Figure A.2.2 and step 1 in Figure A.2.3).

A 50 mm height strip of CONLIT® 150 P slab is cut to size and fitted to fill the gap of maximum 50 mm between floor edge and the vertically installed slabs. See Figure A.2.1 and step 2 in Figure A.2.3. This slab strip shall be compressed at approximately 4 % of its original thickness when installed in slab direction A-A and 2 % in slab direction B-B or C-C (see Figure A.2.4 for compression directions). Compression properties of the slab are given in Table A.2.3.

A strip of 200 mm width of CONLIT® 150 P slab is installed at the bottom side of the floor, held by blades CONLIT® MC at mid slab thickness and butt jointed to the vertically installed slabs. Blades are fixed to the floor with anchors CONLIT® MC at a maximum distance of 400 mm centres (see Figure A.2.2 and step 2 in Figure A.2.3).

On the upper side of the floor, a vertical layer of 250 mm height CONLIT® 150 P slabs is fixed from inside to the external layer of slabs with screws CONLIT® ACR 100 at a maximum distance of 400 mm centres (see Figure A.2.2 and step 3 in Figure A.2.3).

At the bottom side of the floor, a vertical layer of 600 mm height CONLIT® 150 P slabs is fixed to the external layer of slabs with a double line of screws CONLIT® ACR 100 at a maximum distance of 400 mm centres; minimum distance between slabs joints is 1200 mm.

All linear joints are sealed with intumescent mastic. Movement capability of the joint and gap seal is not required due to installation conditions of the system.

Figure A.2.2: Elevation of CONLIT® MC system.

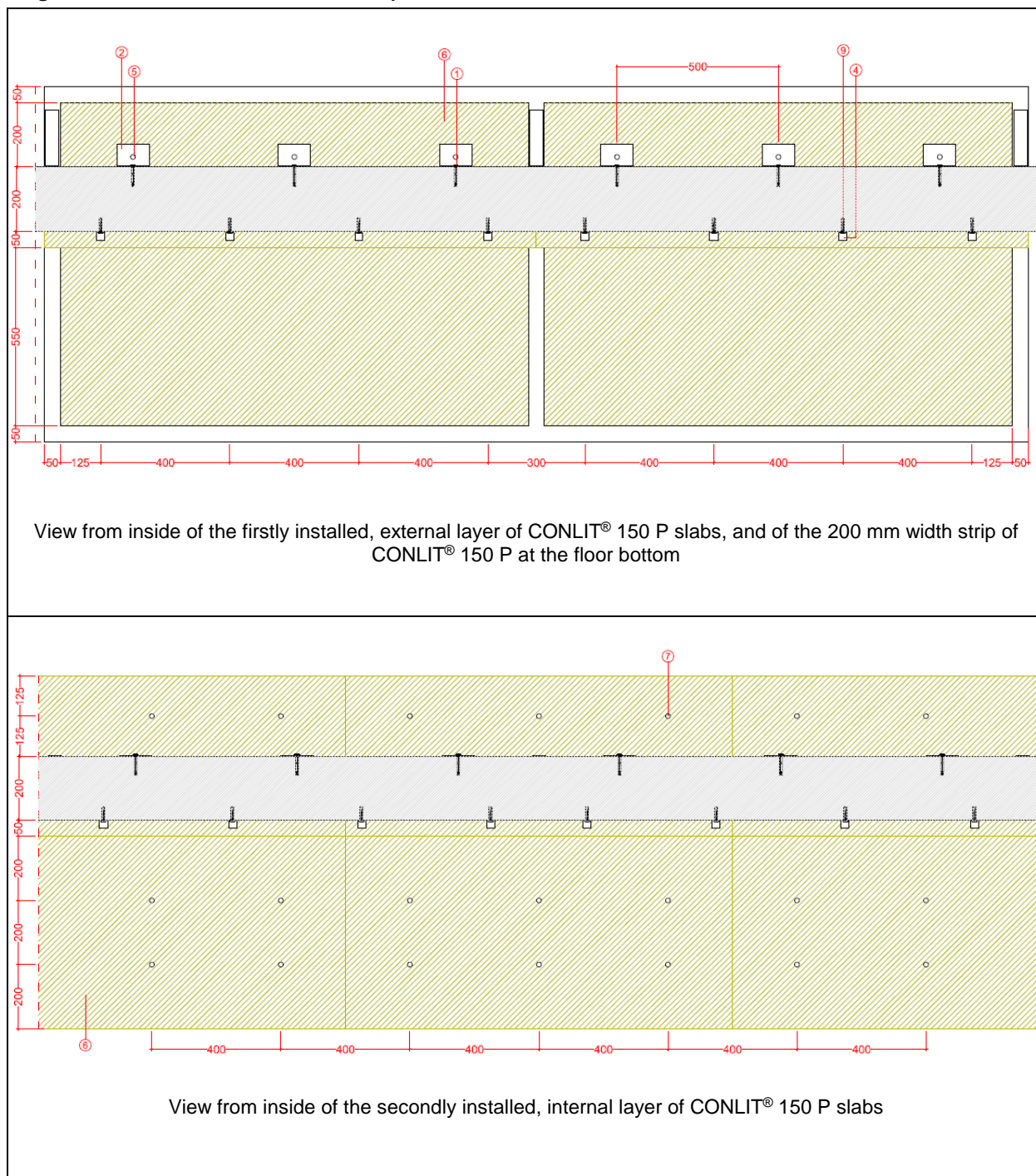

Figure A.2.3: Installation process.

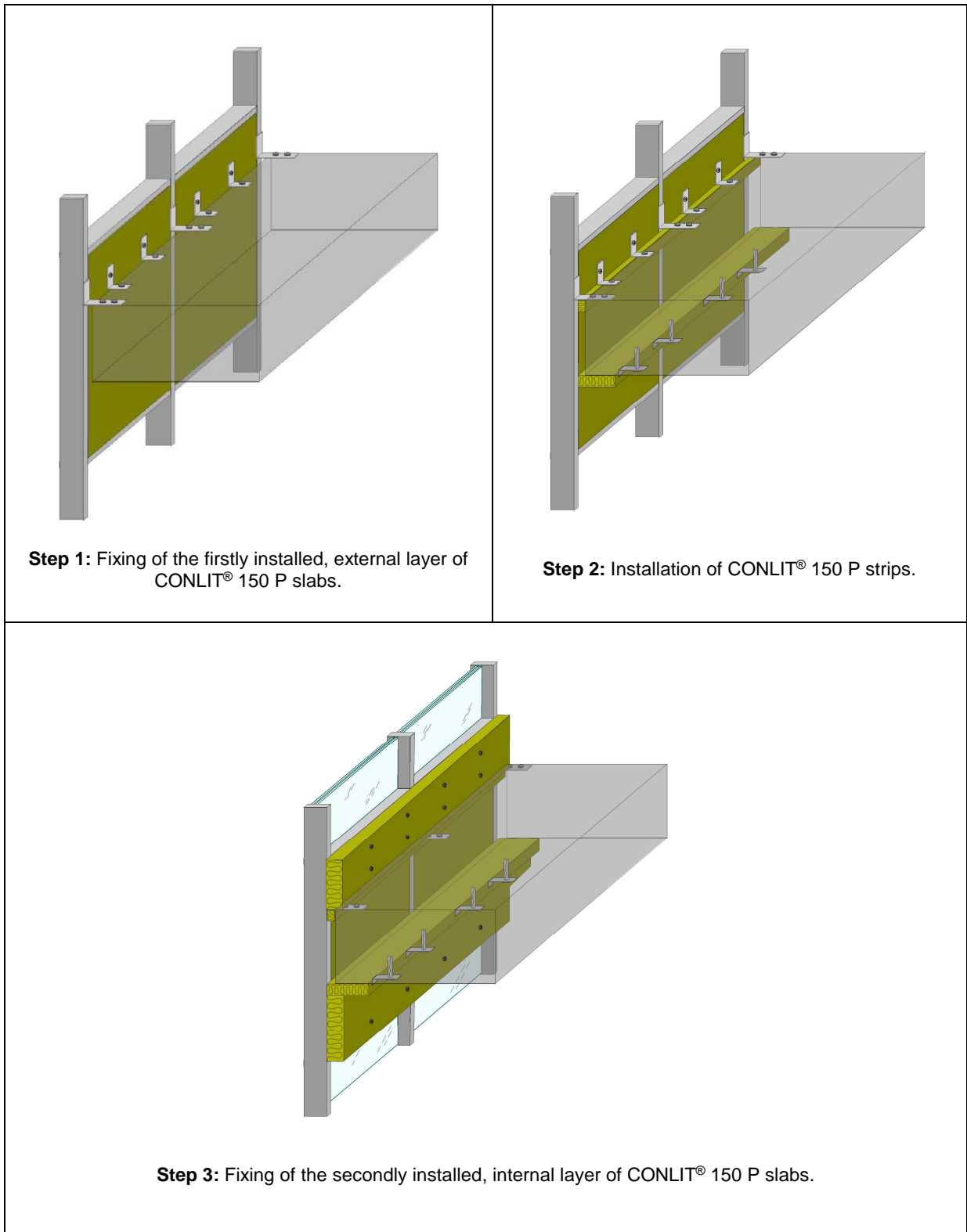
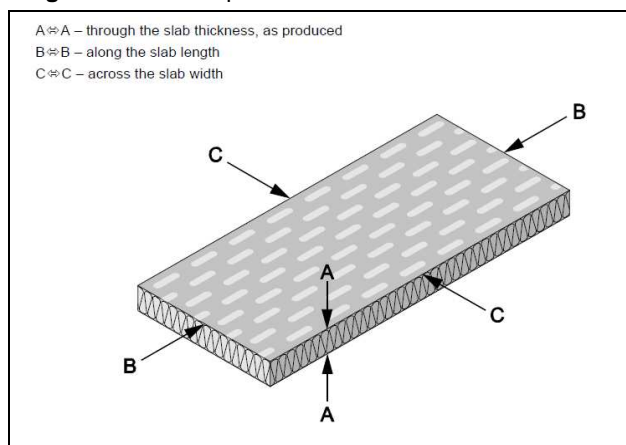

Table A.2.3: Compression characteristics of CONLIT® 150 P 50 mm.

Characteristic	Method	Performance		
Compressive strength (σ_{10}) (in kPa)	EN 826 ¹³	Direction A-A	17,0	
		Direction B-B	59,9	
		Direction C-C	101,7	
Compressibility (in mm)	EN 13162 and EN 12431 ¹⁴	Direction A-A	d_L	50,0
			d_F	49,9
			d_B	49,6
		Direction B-B	c	0,4
			d_L	49,9
			d_F	49,9
		Direction C-C	d_B	49,7
			c	0,3
			d_L	49,8
		Direction C-C	d_F	49,8
			d_B	49,6
			c	0,2

d_L : thickness under 250 Pa
 d_F : thickness under 2 kPa
 d_B : thickness under 2 kPa after applying a load of 48 kPa during 120 s
c: compressibility ($d_B - d_L$)

Figure A.2.4: Compression directions.

¹³ EN 826:2013. *Thermal insulating products for building applications. Determination of compression behaviour.*

¹⁴ EN 12431:2013. *Thermal insulating products for building Applications. Determination of thickness for floating floor insulating products.*

ANNEX 3. Installation of CONLIT® FP system related to resistance to fire performance

A.3.1. General

System CONLIT® FP shall be installed as described in this Annex to meet the resistance to fire classification given in Table A.1.1.

The components of CONLIT® FP system shall be those given in Table A.3.1 and design provisions be in accordance with Figure A.3.1 and A.3.2.

A.3.2. Supporting structure

The supporting structure is a reinforced concrete floor with a thickness of at least 200 mm and a density of at least 2000 kg/m³. The tested floor was 3 m length and 1 m width.

A.3.3. Framing system

The framing system was not part of the tested assembly, only the spandrel panels.

A.3.4. CONLIT® FP system

CONLIT® FP system consists of the components specified in next table.

Table A.3.1: Components of the system CONLIT® FP.

Component	Characteristics	
CONLIT® 150 P	See Table 1.	
Angle brace CONLIT® FP Upper	Galvanised steel DX51D+Z275 Dimensions: (70+200) x 100 x 3 mm	
Angle brace CONLIT® FP Lower	Galvanised steel DX51D+Z275 Dimensions: (40+350+60) x 100 x 3 mm	
Screw CONLIT® ACR 100	Phosphate steel SL (zinc 8 µm to 12 µm) according to EN 10270-1 Length: 100 mm; Ø 13 mm	

Table A.3.1: Components of the system CONLIT® FP.

Component	Characteristics
Metal expansion anchor	Self-tapping screw and sleeve of galvanised steel (5 µm zinc) $d_0 = 8 \text{ mm}$; $h_1 = 40 \text{ mm}$ Tension strength in C20/25 concrete: 5 kN Shear strength in C20/25 concrete: 7 kN
Intumescent mastic	Acrylic resin EI 120 when tested as linear joint seal according to EN 1366-4



Figure A.3.1: Vertical section of installed CONLIT® FP system.

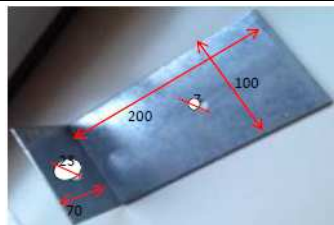
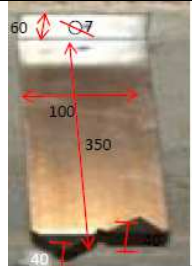
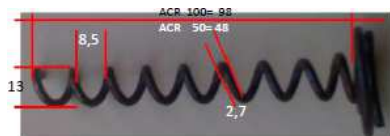
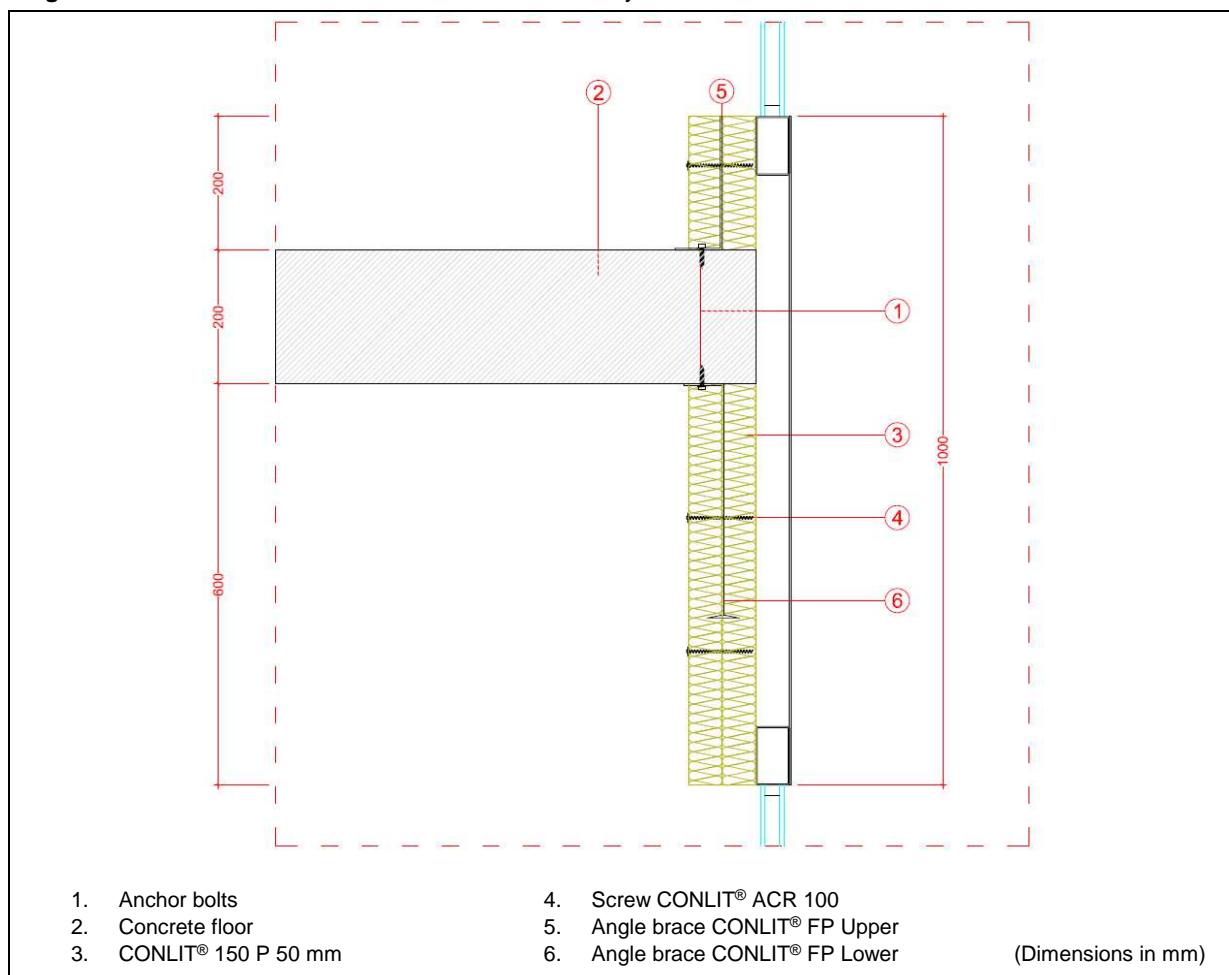

Angle braces CONLIT® MC Upper are fixed on top of the floor and angle braces CONLIT® MC Lower are fixed beneath the floor with anchor bolts at a maximum distance of 500 mm centres (see Figure A.3.2 and step 1 in Figure A.3.3).

A 200 mm height strip of CONLIT® 150 P slabs is placed on the floor between the floor edge and the angle braces CONLIT® MC Upper. A 600 mm height layer of CONLIT® 150 P slabs is placed beneath

the floor between the floor edge and the angle braces CONLIT® MC Lower, and retained by the pin at the end of the angle brace. Minimum distance between slabs vertical joints is 1200 mm.

On the upper side of the floor, a 200 mm height strip of CONLIT® 150 P slabs is fixed to the first, external layer of CONLIT® 150 P slabs with screws CONLIT® ACR 100 at a maximum distance of 400 mm centres. Minimum distance between slabs vertical joints is 1200 mm (see Figure A.3.2 and step 3 in Figure A.3.3).

At the bottom side of the floor, a 600 mm height layer of CONLIT® 150 P slabs is fixed to the external layer of slabs with a double line of screws CONLIT® ACR 100 at a maximum distance of 400 mm centres. Minimum distance between slabs vertical joints is 1200 mm (see Figure A.3.2 and step 3 in Figure A.3.3).

Vertical joints between slabs of the firstly installed, external layer, shall not be coincident with those of the secondly installed, internal layer of CONLIT® 150 P slabs. All linear joints are sealed with intumescent mastic. Movement capability of the joint is not required due to installation conditions of the system.

Figure A.3.2: Elevation of CONLIT® FP system.

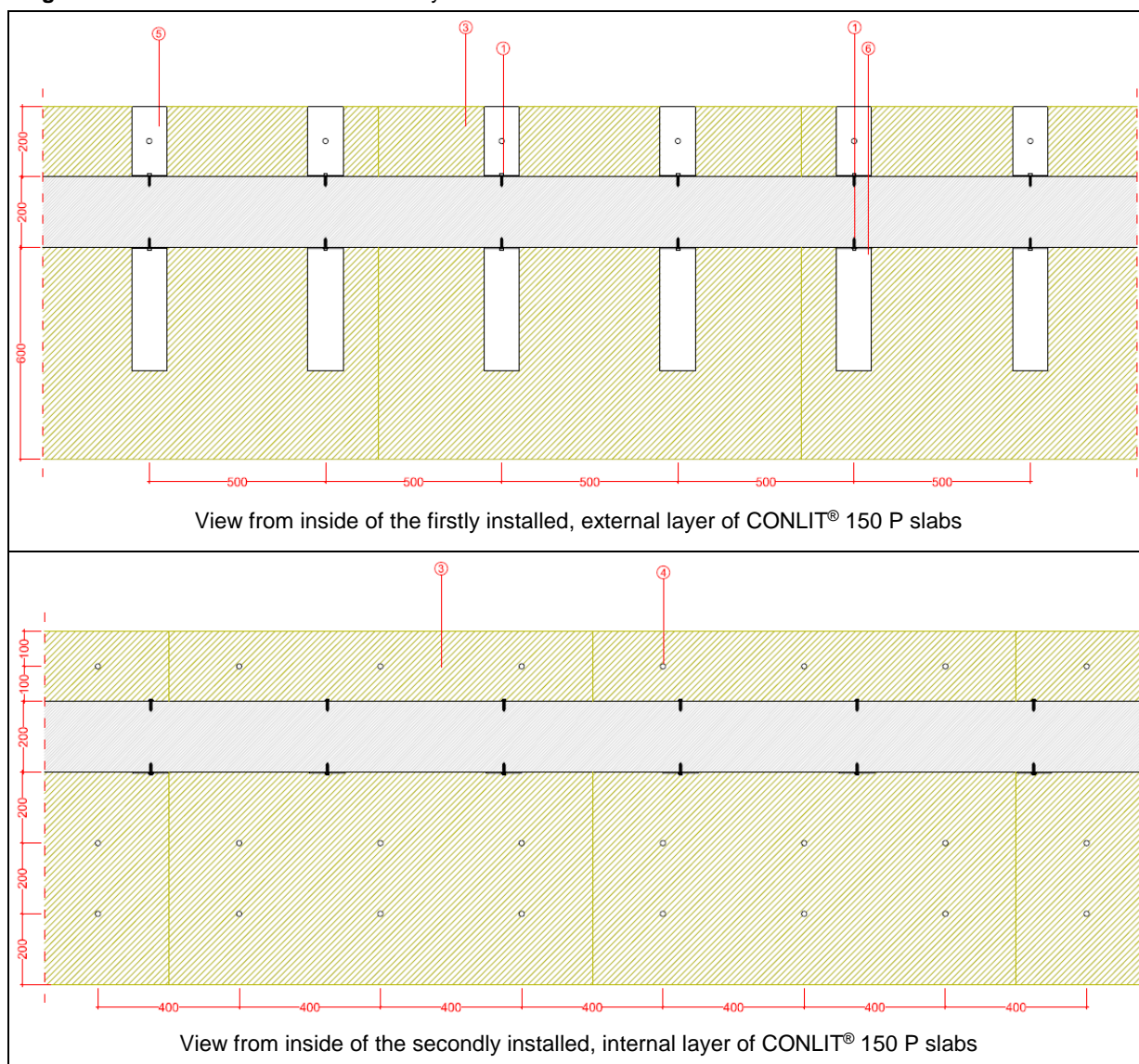

Figure A.3.3: Installation process.

