



European Technical Assessment

ETA 21/0580
of 12.11.2021



General part

Technical Assessment Body issuing the ETA: ITeC

ITeC has been designated according to Article 29 of Regulation (EU) No 305/2011 and is member of EOTA (European Organisation for Technical Assessment).

Trade name of the construction product

AF BRICK

Product family to which the construction product belongs

Fire stopping and fire sealing products.
Penetration seals.

Manufacturer

AF SYSTEMS SRL
Via Edward Jenner 41-43
IT-26837 Mulazzano
Italy

Manufacturing plant(s)

According to Annex N kept by ITeC.

This European Technical Assessment contains

19 pages including 1 annex which forms an integral part of this assessment

and

Annex N, which contains confidential information and is not included in the European Technical Assessment when that assessment is publicly available.

This European Technical Assessment is issued in accordance with Regulation (EU) 305/2011, on the basis of

European Assessment Document EAD 350454-00-1104.

General comments

Translations of this European Technical Assessment in other languages shall fully correspond to the original issued document.

Communication of this European Technical Assessment, including transmission by electronic means, shall be in full (excepted the confidential Annex(es)).

Specific parts of the European Technical Assessment

1 Technical description of the product

AF BRICK is an intumescent block made of a bi-component thermo expansive foam used as fire penetration seal, with the characteristics shown in the next table.

Table 1: Characteristics of AF BRICK.

Characteristic	Nominal value
Dimensions	(150 x 150 x 50) mm
Density	240 ± 10 % kg/m ³
Weight	0,24 – 0,30 kg
Expansion ratio	6,64 (-)
Expansion pressure (at 500 °C)	1,19 N/mm ²

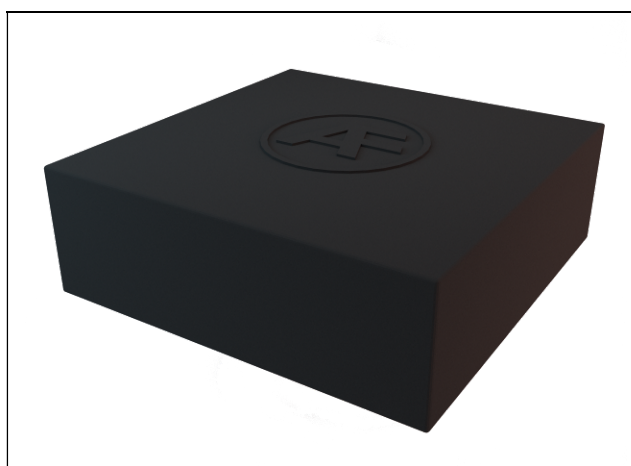

Figure A.1: AF BRICK.

The description of the installation procedure is given in Annex A. Assembled penetration seals require additional components as described in Annex A. These components cannot be CE marked based on this ETA.

2 Specification of the intended use(s) in accordance with the applicable EAD

AF BRICK is used to reinstate the resistance to fire performance of flexible or rigid wall and rigid floor constructions where they are penetrated by services (combustible pipes, multilayer composite pipes, cables and cables trays, insulated and non-insulated metal pipes). The detailed specification of the services that may be protected with AF BRICK are given in Annex A. The specific elements of construction, where the AF BRICK may be used to provide a penetration seal, are as follows:

- Flexible walls: Walls with a minimum thickness of 120 mm, which comprise timber or steel studs lined on both faces with minimum two layers of 12,5 mm thick 'Type F' or 'Type DF' gypsum plasterboards according to EN 520¹. In timber stud walls, no part of the penetration shall be closer than 100 mm to a stud, the cavity must be closed between the penetration seal and the stud and minimum 100 mm of insulation of reaction to fire class A1 or A2, according to EN 13501-1², is provided within the cavity between the penetration seal and the stud.
- Rigid walls: Concrete or masonry walls with a minimum thickness of 120 mm and a minimum density of 500 kg/m³.
- Rigid floors: Light weight concrete or other type of rigid floors with a minimum thickness of 150 mm and a minimum density of 1600 kg/m³.

The constructive element where the intumescent bricks are installed must be classified in accordance with EN 13501-2³ for the required fire resistance period.

AF BRICK is intended for the environmental conditions as defined for use category Type Y₁ according to EAD 350454-00-1104: intended for semi-exposed use at temperatures below 0°C, with exposure to UV but not to rain. Type Y₁ includes lower use categories (i.e. Type Y₂, Type Z₁ and Type Z₂).

The provisions made in this ETA are based on a working life of AF BRICK of at least 25 years, provided that the conditions laid down in the manufacturer's instructions for the installation, use and maintenance are met. These provisions are based upon the current state of the art and the available knowledge and experience.

The indications given as to the working life of the product cannot be interpreted as a guarantee but are regarded only as a means for choosing the appropriate products in relation to the expected economically reasonable working life of the works.

¹ EN 520 Gypsum plasterboards. Definitions, requirements and test methods.

² EN 13501-1 Fire classification of construction products and building elements. Part 1: Classification using data from reaction to fire tests.

³ EN 13501-2 Fire classification of construction products and building elements. Part 2: Classification using data from fire resistance tests, excluding ventilation services.

3 Performance of the product and reference to the methods used for its assessment

3.1 Performance of the product

The assessment of AF BRICK has been performed in accordance with EAD 350454-00-1104 for *Fire stopping and fire sealing products - Penetration seals (September 2017)*.

Table 2: Performance of the product.

Product: AF BRICK		Intended use: Fire penetration seal	
Basic requirement	Essential characteristic	Performance	
	Reaction to fire	NPA ⁴	
BWR 2 Safety in case of fire	Resistance to fire	Walls	EI 120 (see Annex A)
		Floors	EI 180 (see Annex A)
			EI 240 (see Annex A, A.4)
BWR 4 Safety and accessibility in use	Durability	Type Y ₁	

The rest of characteristics included in EAD 350454-00-1104 have not been assessed in this ETA.

3.2 Methods used for the assessment

3.2.1 Fire resistance

The performance of AF BRICK has been tested and assessed according to EN 1366-3⁵. The classification of the resistance to fire has been determined according to EN 13501-2 and is given in Annex A.

3.2.2 Durability

AF BRICK has been tested and assessed for the environmental use category Type Y₁ in accordance with section 2.2.9 of EAD 350454-00-1104 and the EOTA Technical Report 024⁶, section 2.2.4 (for a 25-year working life).

⁴ NPA: No Performance Assessed.

⁵ EN 1366-3 Fire resistance tests for service installations. Part 3: Penetration seals (2009).

⁶ EOTA TR 024 Technical description and assessment of reactive products effective in case of fire, Edition August 2019.

4 Assessment and verification of constancy of performance (AVCP) system applied, with reference to its legal base

According to the Decision 1999/454/EC of the European Commission, the system of AVCP (see EC delegated Regulation (EU) No 568/2014 amending Annex V to Regulation (EU) 305/2011) given in the following table applies.

Table 3: AVCP System.

Product(s)	Intended use(s)	Level(s) or class(es)	System(s)
Fire stopping and fire sealing products	For fire compartmentation and/or fire protection or fire performance	Any	1

5 Technical details necessary for the implementation of the AVCP system, as foreseen in the applicable EAD

All the necessary technical details for the implementation of the AVCP system are laid down in the *Control Plan* deposited with the ITeC and agreed in accordance with EAD 350454-00-1104, section 3.

The *Control Plan* is a confidential part of the ETA and only handed over to the notified product certification body involved in the assessment and verification of constancy of performance.

The factory production control operated by the manufacturer shall be in accordance with the above mentioned *Control Plan*.

Issued in Barcelona on 12 November 2021

by the Catalonia Institute of Construction Technology.



Ferran Bermejo Nualart
Technical Director, ITeC

ANNEX A. Resistance to fire performance

A.1. Resistance to fire classification

Table A.1: Resistance to fire classification.

Constructive element	Installation description	Technical services	Resistance to fire
Walls in accordance with section 2	Section A.2	Section A.3.1	EI 120
Floors in accordance with section 2	Section A.2	Section A.3.2	EI 180
Floor in accordance with section A.4.1	Section A.4.1	Section A.4.2	EI 240

A.2. Description of the installation procedure

A.2.1. General

AF BRICK will be installed in accordance with the manufacturer instructions and the provisions in this annex.

AF BRICK is placed inside the penetration, orienting the brick side of 150 mm parallel to the thickness of the support, up to the complete obstruction of the opening. Small gaps between services and AF BRICK can be filled with AF GRAPHIT FOAM, particularly if greater than 5 mm.

The maximum distance from the constructive element to the adequate service support is 500 mm in case of walls (cold side) and floors (upper side).

The following installation provisions will be noted:

- The installation of the penetration seal will not have an effect on the stability of the adjacent building element, even in the event of fire.
- The structural elements related to the wall/floor in which the penetration seal is incorporated will be designed and fire protected in such a way that no additional mechanical load is imposed on the penetration seal.
- The thermal movements of the pipework will be accommodated in such a way that no resulting load is imposed on the penetration seal.
- The services are fixed to the building element in such a way that no additional mechanical load is imposed on the penetration seal in the event of fire.
- The support of the services is maintained during the required period of resistance to fire.
- Pneumatic dispatch systems, compressed air systems, etc. are switched off in the event of fire.

A.2.2. Installation conditions for flexible and rigid walls

The maximum seal size will be 0,6 m² with a maximum height of 1050 mm. The total amount of cross sections of the services (including insulation) will not exceed 60 % of the AF BRICK seal area.

The minimum distance from services to AF BRICK seal edge will be 50 mm and the minimum distance between services within AF BRICK seal will be 90 mm.

A blank penetration seal (seal without services) can be installed and has the same resistance to fire performance as the seal with services (EI 120), provided that a reinforcement net made of 1 mm diameter steel cable is installed at the fire-exposed side of the wall, supporting the AF BRICK blank seal. The cable is fixed to the wall around the seal with self-tapping screws of Ø8 mm x 120 mm in the case of flexible walls and expansion anchors of Ø8 mm x 60 mm in the case of rigid walls (approximately one fixing every 230 mm of seal lateral dimension), with a cable distribution as shown in figure A.2. This reinforcement net is not necessary if services pass through the seal.

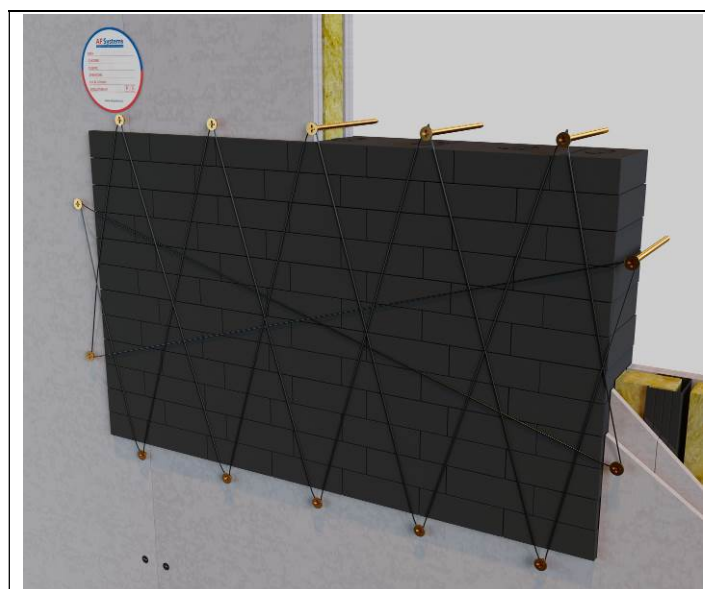

Figure A.2: Example of reinforcement net for a blank penetration seal in walls.

A.2.3. Installation conditions for rigid floors

The maximum seal size will be 0,6 m². The total amount of cross sections of the services (including insulation) will not exceed 60 % of the AF BRICK seal area.

The minimum distance from services to AF BRICK seal edge will be 50 mm and the minimum distance between services within AF BRICK seal will be 60 mm.

A reinforcement net of 1 mm diameter steel cable is installed below the seal in openings bigger than 0,4 m². The cable is fixed to the floor around the seal with expansion anchors of Ø8 mm x 60 mm (approximately 1 anchor every 150 mm of seal lateral dimension), with a cable distribution as shown in figure A.3.

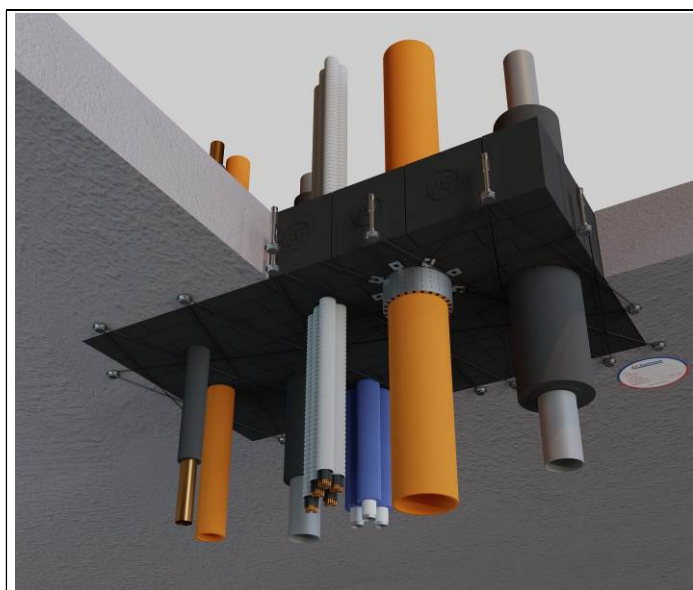

Figure A.3: Example of reinforcement net for penetration seals bigger than 0,4 m² in floors.

A blank penetration seal (seal without services) can be installed and has the same resistance to fire performance as the seal with services (EI 180), provided that a reinforcement net made of 1 mm diameter steel cable is installed below the seal, supporting the AF BRICK blank seal. The cable is fixed to the floor around the seal with expansion anchors of Ø8 mm x 60 mm (approximately 1 fixing every 130 mm of seal lateral dimension), with a cable distribution as shown in figure A.4.

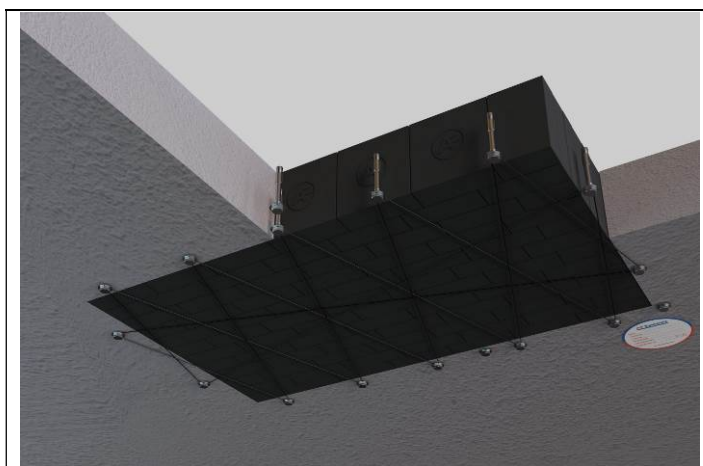

Figure A.4: Example of reinforcement net for a blank penetration seal in floors.

A.3. Assessed technical services

A.3.1. Services passing through flexible or rigid walls

The following services can be installed in an AF BRICK penetration seal in accordance with section A.1 of this ETA and have a resistance to fire performance EI 120.

Table A.2: Plastic pipes (U/C)⁷.

Material	External pipe diameter (mm)	Pipe wall thickness (mm)	Intumescent collar
	63	3,0 – 5,8	---
PVC ⁸	110	3,2 – 8,1	AF COLLAR 110 or AF MULTICOLLAR 110 ⁹ , installed at both sides of the wall and fixed with 4 steel wires of diameter 1 mm, from the collar flanges to the wall substructure where the cables are fixed with Ø3,5 x 55 mm self-tapping steel screws.

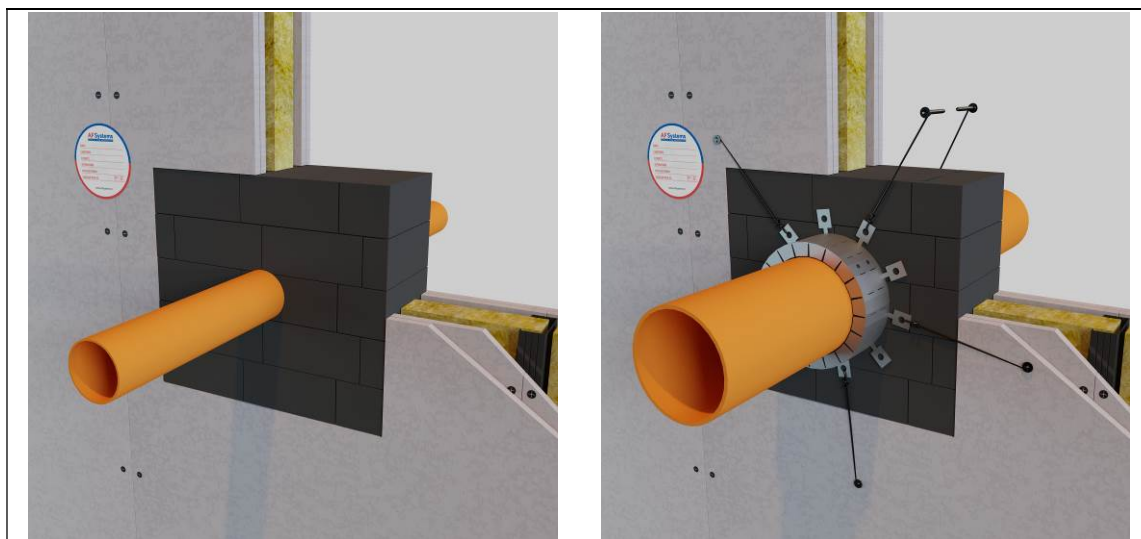

Figure A.5: Examples of AF BRICK penetration seal of plastic pipes in flexible walls.

Table A.3: Bundle of insulated multilayer composite pipes (U/C).

Material	External pipe diameter (mm)	Pipe wall thickness (mm)	Number of pipes	Insulation
PE-Xb / Al / HDPE	20	3	≤ 3	Every single composite pipe is insulated according to table A.4

⁷ Regarding the pipe end configuration, according to section 2.2.2 of EAD 350454-00-1104, a classification given for a configuration U/C is also valid for a pipe end configuration C/U and C/C. Definition of the pipe end configuration is given in section 6.3.4 of EN 1366-3.

⁸ PVC-U according to EN 1329-1, EN 1453-1 and EN ISO 1452-1, and PVC-C according to EN 1566-1.

⁹ AF COLLAR in accordance with ETA 16/0891 and AF MULTICOLLAR in accordance with ETA 16/0771.

Table A.4: Insulation of multilayer composite pipes.

Material	Internal diameter (mm)	Thickness (mm)	Reaction to fire	Type
Expanded PE	20	6	F	CS ¹⁰

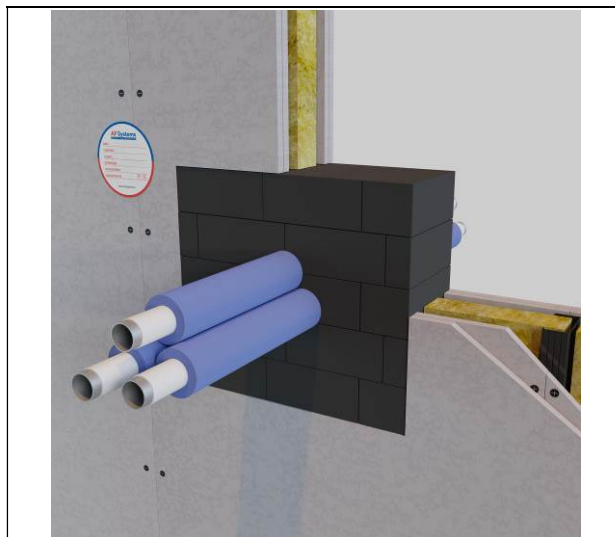
**Figure A.6:** Example of AF BRICK penetration seal of multilayer composite pipes in flexible walls.**Table A.5:** Cables.

Service	Cables specification
Steel cable tray of section 300 mm x 75 mm and sheet thickness of 1 mm	<ul style="list-style-type: none"> - Type "small-sheathed cables" (Group 1 according to Annex A of EN 1366-3): <ul style="list-style-type: none"> 10 cables A1 model "5×1,5 mm² CI 1 PVC/PVC 600/1000V NYYJ". 10 cables A2 model "5×1,5 mm² CI 5 Cu EPR/PCP 450/750V H07RN-F". 10 cables A3 model "5×1,5 mm² CI 1 Cu XLPE/LSZH 600/1000V N2XH-J". 2 cables B model "1×95 mm² CI 2 PVC/PVC 600/1000V NYY0". The cables shall be in accordance with section A.3.1.1 ¹¹ of EN 1366-3 with a maximum cable diameter of 21 mm. - Bundle of 3 corrugated PVC pipes of diameter 20 mm each, with a cable of 5x1,5 mm² in every pipe (model A1, A2 or A3 according to EN 1366-3).
Bundle of 5 corrugated PVC pipes of diameter 20 mm each	A cable of 5x1,5 mm ² in every pipe (model A1, A2 or A3 according to EN 1366-3).

¹⁰ Continuous insulation according to EN 1366-3.

¹¹ EN 1366-3, A.3.1.1: All cable types currently and commonly used in building practice in Europe except non-sheathed cables (wires), tied bundles and waveguides; optical fibre cables are covered.

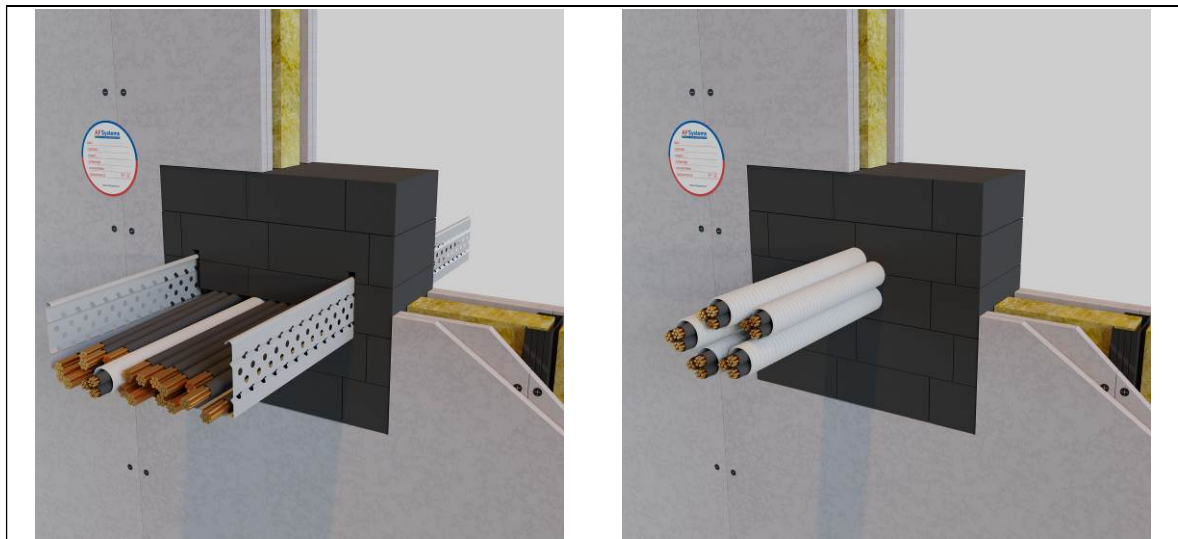

Figure A.7: Examples of AF BRICK penetration seal of cables in flexible walls.

Table A.6: Insulated metal pipes (C/C).

Metal pipe			Insulation	
External diameter (mm)	Wall thickness (mm)	Material	Thickness (mm)	Characteristics
108	4 – 18,2	Steel with a minimum melting point of 1370 °C and a maximum thermal conductivity of 52 W/(m·K)	20 – 40	<ul style="list-style-type: none"> - Foamed elastomeric continuous insulation. - Reaction to fire: D_L-s3,d0. - Maximum thermal conductivity (23 °C): $\lambda \leq 0,043 \text{ W/(m}\cdot\text{K)}$.

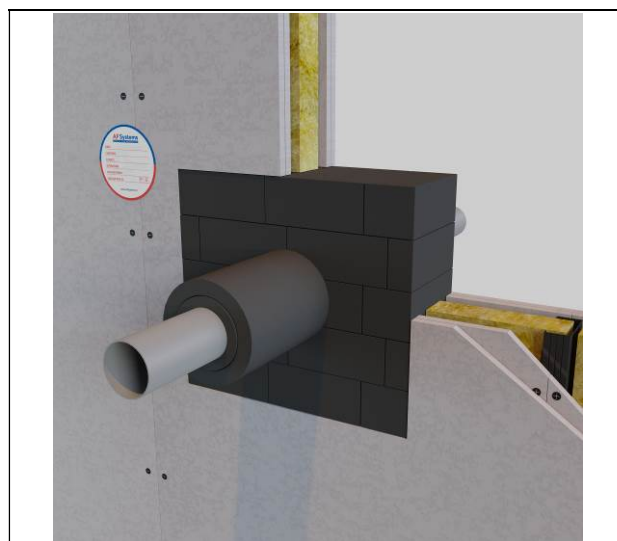

Figure A.8: Example of AF BRICK penetration seal of insulated steel pipes in flexible walls.

Table A.7: Protected metal pipes (C/C).

Metal pipe			Fire protection (AF PIPEGUARD)	
External diameter (mm)	Wall thickness (mm)	Material	Thickness	Characteristics
108	4 – 18,2	Steel with a minimum melting point of 1370 °C and a maximum thermal conductivity of 52 W/(m·K)	14 mm (2 layers of 7 mm each)	<ul style="list-style-type: none"> - Length: 240 mm. - Installed at the fire non-exposed side of the wall. - Fixed with steel wire of diameter 1 mm.
20	2 – 9	Copper with a minimum melting point of 1085 °C and a maximum thermal conductivity of 390 W/(m·K)	14 mm (2 layers of 7 mm each)	
20 (*)			7 mm (1 layer)	

(*) Insulated pipe according to table A.8.

Table A.8: Insulation of protected metal pipes.

Material	Internal diameter (mm)	Thickness (mm)	Reaction to fire	Type
Expanded PE	20	6	F	CS ¹²

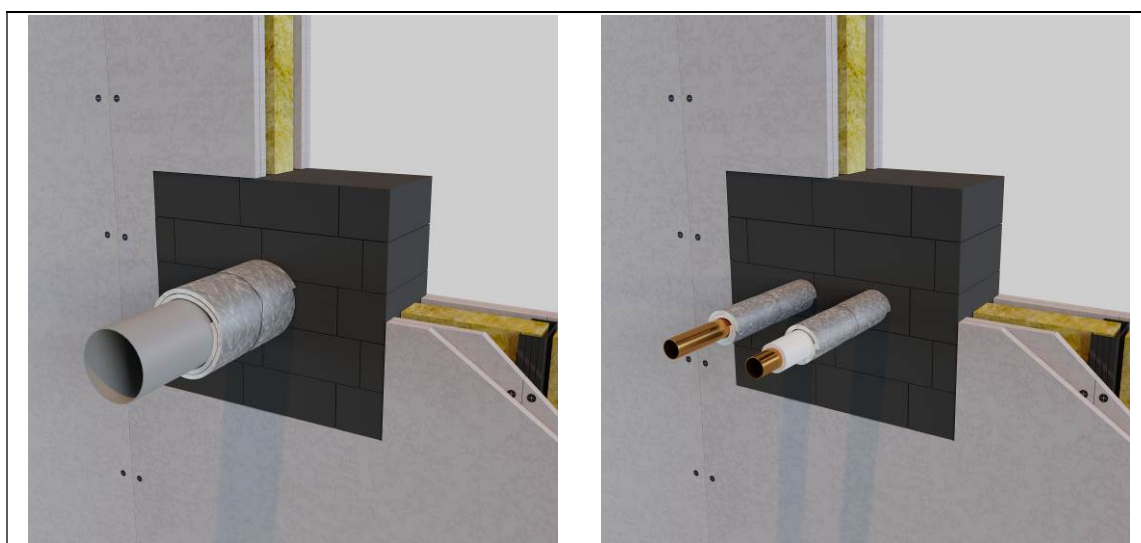
**Figure A.9:** Examples of AF BRICK penetration seal of protected metal pipes in flexible walls.

¹² Continuous insulation according to EN 1366-3.

A.3.2. Services passing through rigid floors

The following services can be installed in an AF BRICK penetration seal in accordance with section A.1 of this ETA and have a resistance to fire performance EI 180.

Table A.9: Plastic pipes (U/C)¹³.

Material	External pipe diameter (mm)	Pipe wall thickness (mm)	Intumescent collar
	63	3,0 – 5,8	---
PVC ¹⁴	110	3,2 – 8,1	AF COLLAR 110 or AF MULTICOLLAR 110 ¹⁵ , installed at fire exposed side only (below the seal) and fixed with 4 steel wires of diameter 1 mm, from the collar flanges to the floor where the cables are fixed with Ø8 x 60 mm expansion anchors.

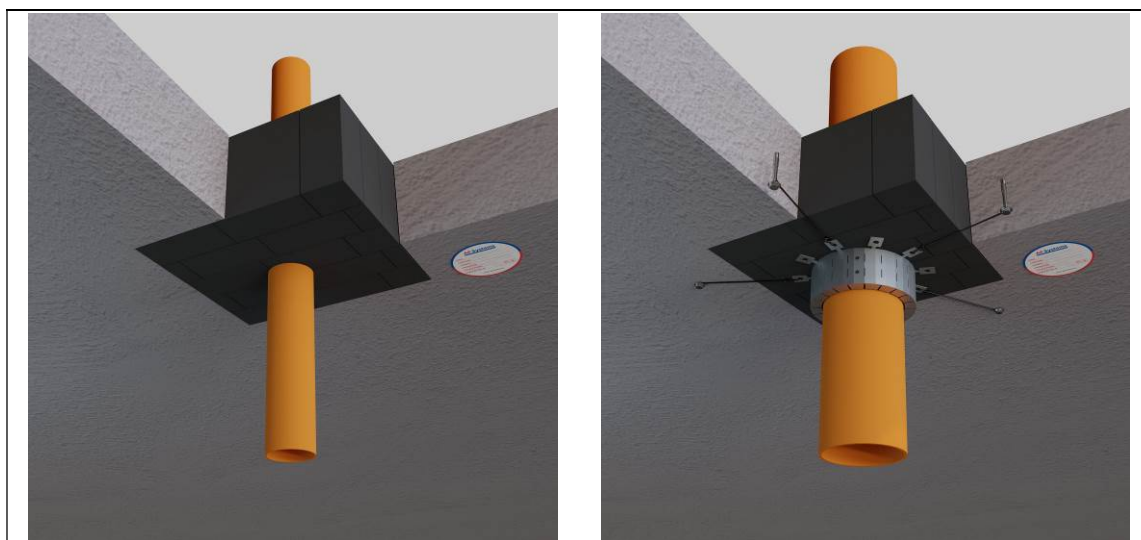

Figure A.10: Example of AF BRICK penetration seal of plastic pipes in floors.

Table A.10: Bundle of insulated multilayer composite pipes (U/C).

Material	External pipe diameter (mm)	Pipe wall thickness (mm)	Pipes quantity	Insulation
PE-Xb / Al / HDPE	20	3	≤ 3	Every single composite pipe is insulated according to table A.11

¹³ Regarding the pipe end configuration, according to section 2.2.2 of EAD 350454-00-1104, a classification given for a configuration U/C is also valid for a pipe end configuration C/U and C/C. Definition of the pipe end configuration is given in section 6.3.4 of EN 1366-3.

¹⁴ PVC-U according to EN 1329-1, EN 1453-1 and EN ISO 1452-1, and PVC-C according to EN 1566-1.

¹⁵ AF COLLAR in accordance with ETA 16/0891 and AF MULTICOLLAR in accordance with ETA 16/0771.

Table A.11: Insulation of multilayer composite pipes.

Material	Internal diameter (mm)	Thickness (mm)	Reaction to fire	Type
Expanded PE	20	6	E	CS ¹⁶

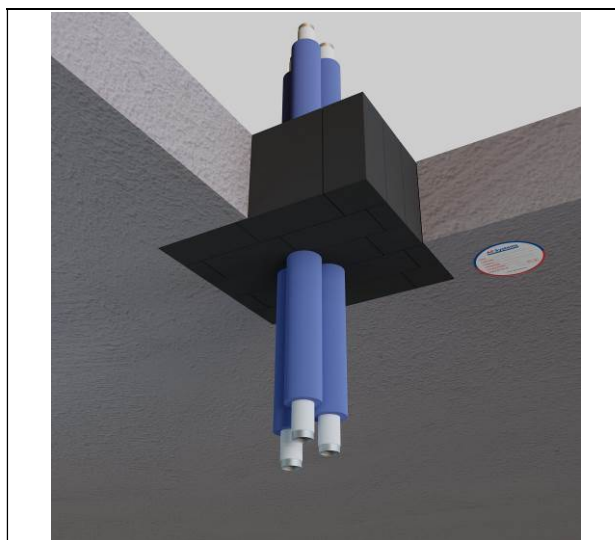
**Figure A.11:** Example of AF BRICK penetration seal of multilayer composite pipes in floors.**Table A.12:** Cables.

Service	Cables specification
Steel cable tray of section 300 mm x 75 mm and sheet thickness of 1 mm	<ul style="list-style-type: none"> - Type "small sheathed cables" (Group 1 according to Annex A of EN 1366-3): <ul style="list-style-type: none"> 10 cables A1 model "5×1,5 mm² CI 1 PVC/PVC 600/1000V NYYJ". 10 cables A2 model "5×1,5 mm² CI 5 Cu EPR/PCP 450/750V H07RN-F". 10 cables A3 model "5×1,5 mm² CI 1 Cu XLPE/LSZH 600/1000V N2XH-J". 2 cables B model "1×95 mm² CI 2 PVC/PVC 600/1000V NYY0". The cables shall be in accordance with section A.3.1.1¹⁷ of EN 1366-3 with a maximum cable diameter of 21 mm. - Bundle of 2 corrugated PVC pipes of diameter 20 mm each, with a cable of 5x1,5 mm² in every pipe (model A1, A2 or A3 according to EN 1366-3).
Bundle of 5 corrugated PVC pipes of diameter 21,2 mm each	A cable of 5x1,5 mm ² in every pipe (model A1, A2 or A3 according to EN 1366-3).

¹⁶ Continuous insulation according to EN 1366-3.

¹⁷ EN 1366-3, A.3.1.1: All cable types currently and commonly used in building practice in Europe except non-sheathed cables (wires), tied bundles and waveguides; optical fibre cables are covered.

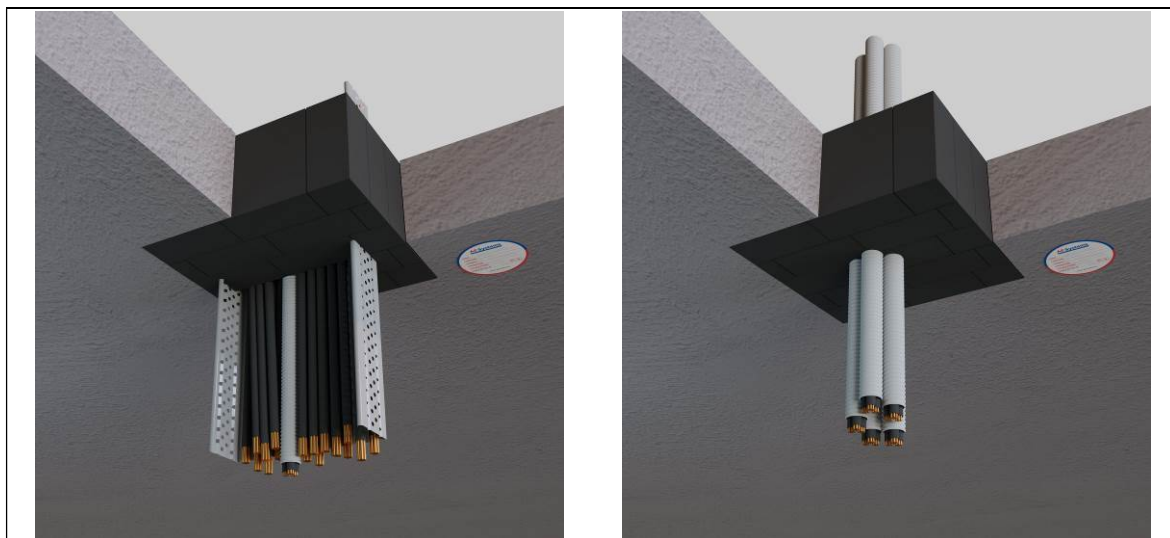

Figure A.12: Examples of AF BRICK penetration seal of cables in floors.

Table A.13: Insulated metal pipes (C/C).

Metal pipe			Insulation	
External diameter (mm)	Wall thickness (mm)	Material	Thickness (mm)	Characteristics
108	4 – 18,2	Steel with a minimum melting point of 1370 °C and a maximum thermal conductivity of 52 W/(m·K)	20 – 40	- Foamed elastomeric continuous insulation. - Reaction to fire: DL-s3,d0.
20	2 – 9	Copper with a minimum melting point of 1085 °C and a maximum thermal conductivity of 390 W/(m·K)	20	- Maximum thermal conductivity (23 °C): $\lambda \leq 0,043$ W/(m·K).

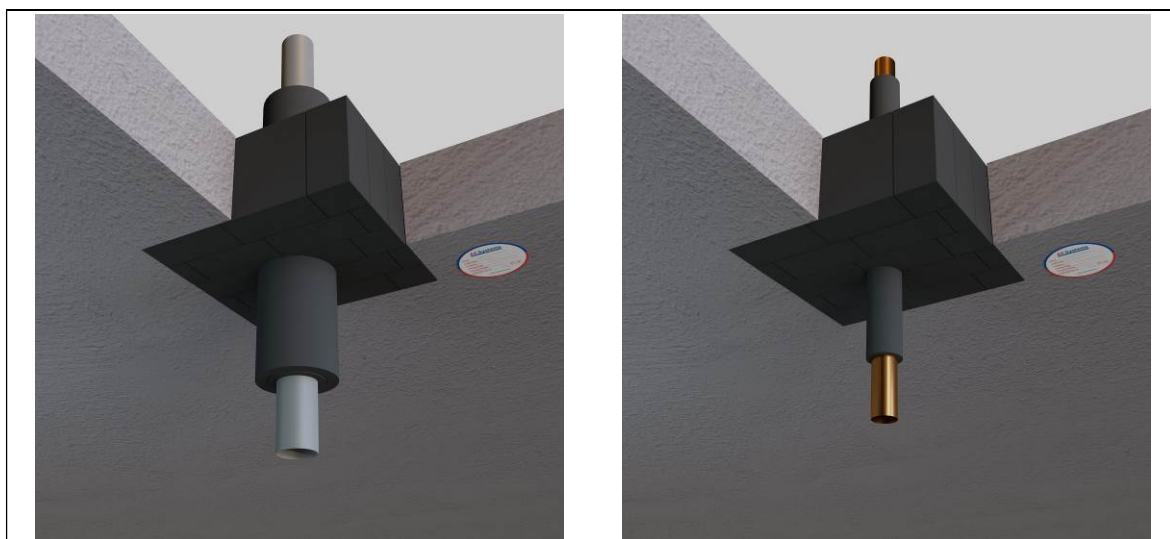
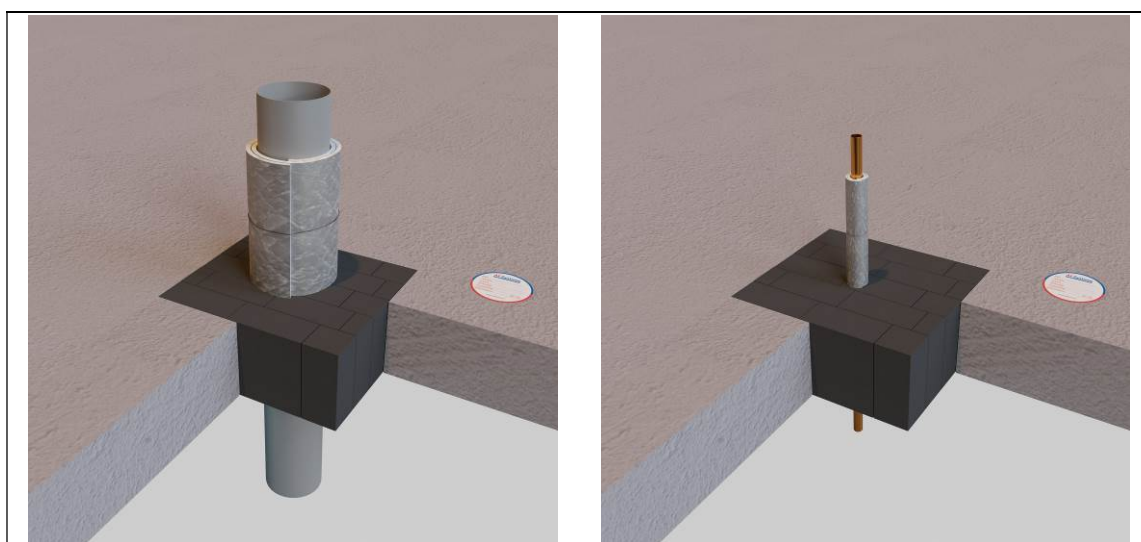

Figure A.13: Examples of AF BRICK penetration seal of insulated metal pipes in floors.

Table A.14: Protected metal pipes (C/C).

Metal pipe			Fire protection (AF PIPEGUARD)	
External diameter (mm)	Wall thickness (mm)	Material	Thickness	Characteristics
108	4 – 18,2	Steel with a minimum melting point of 1370 °C and a maximum thermal conductivity of 52 W/(m·K)	14 mm (2 layers of 7 mm each)	<ul style="list-style-type: none"> - Length: 240 mm. - Installed at the fire non-exposed side (above the seal).
20	2 – 9	Copper with a minimum melting point of 1085 °C and a maximum thermal conductivity of 390 W/(m·K)		<ul style="list-style-type: none"> - Fixed with steel wire of diameter 1 mm.

**Figure A.14:** Examples of AF BRICK penetration seal of protected metal pipes in floors.

A.4. AF BRICK seal with performance EI 240 in floors

A.4.1. Description of the installation procedure

Reinforced light weight concrete or other type of rigid floors with a minimum thickness of 200 mm and a minimum density of 600 kg/m³.

AF BRICK will be installed in accordance with the manufacturer instructions and the provisions in this annex.

AF BRICK is placed inside the penetration, orienting the brick side of 150 mm parallel to the thickness of the floor and adding a 50 mm piece to seal the complete floor thickness (200 mm), up to the complete obstruction of the opening. Small gaps between services and AF BRICK can be filled with AF GRAPHIT FOAM, particularly if greater than 5 mm.

No reinforcement net is required. The resistance to fire of a blank penetration seal (seal without services) has not been assessed for a EI 240 performance and, therefore, the seal shall always be installed with the given services to have the declared performance.

The rest of installation provisions given in A.2.1 shall be taken into account.

A.4.2. Penetration seal and assessed technical services

The size of the AF BRICK seal is 450 mm x 200 mm. Installation of the services shall be in accordance with the next figure.

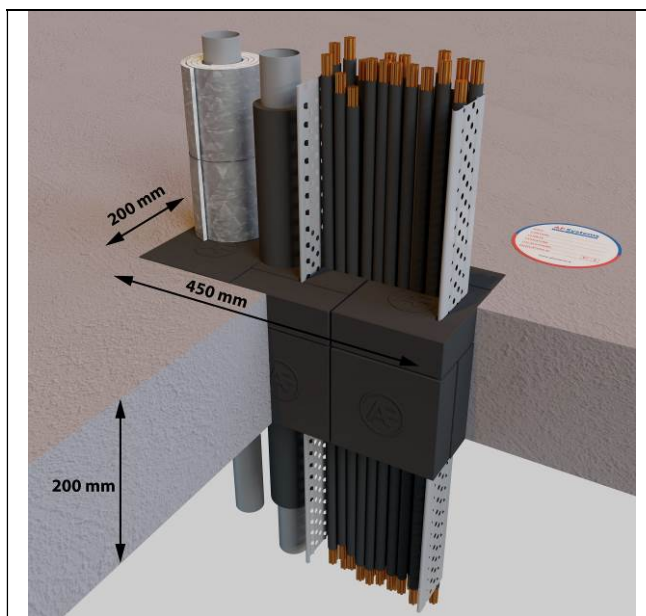

Figure A.15: EI 240 U/C Penetration seal.

The following services can be installed in an AF BRICK penetration seal in accordance with section A.4.1 of this ETA and have a resistance to fire performance EI 240.

Table A.15: Cables.

Service	Cables specification
Steel cable tray of section 200 mm x 80 mm and sheet thickness of 1,5 mm	<p>Type "small-sheathed cables" (Group 1 according to Annex A of EN 1366-3):</p> <p>10 cables A1 model "5×1,5 mm² CI 1 PVC/PVC 600/1000V NYYJ".</p> <p>10 cables A2 model "5×1,5 mm² CI 5 Cu EPR/PCP 450/750V H07RN-F".</p> <p>10 cables A3 model "5×1,5 mm² CI 1 Cu XLPE/LSZH 600/1000V N2XH-J".</p> <p>2 cables B model "1×95 mm² CI 2 PVC/PVC 600/1000V NYY0".</p> <p>The cables shall be in accordance with section A.3.1.1¹⁸ of EN 1366-3 with a maximum cable diameter of 21 mm.</p>

Table A.16: Insulated metal pipes (U/C).

Metal pipe			Insulation	
External diameter (mm)	Wall thickness (mm)	Material	Thickness (mm)	Characteristics
50	1 – 15,2	Steel with a minimum melting point of 1370 °C and a maximum thermal conductivity of 52 W/(m·K)	19	<ul style="list-style-type: none"> - Foamed elastomeric continuous insulation. - Reaction to fire: DL-s2,d0. - Maximum thermal conductivity (23 °C): $\lambda \leq 0,043$ W/(m·K).

Table A.17: Protected metal pipes (U/C).

Metal pipe			Fire protection (AF PIPEGUARD)	
External diameter (mm)	Wall thickness (mm)	Material	Thickness	Characteristics
50	1 – 15,2	Steel with a minimum melting point of 1370 °C and a maximum thermal conductivity of 52 W/(m·K)	28 mm (4 layers of 7 mm each)	<ul style="list-style-type: none"> - Length: 240 mm. - Installed at the fire non-exposed side (above the seal). - Fixed with steel wire of diameter 1 mm.

¹⁸ EN 1366-3, A.3.1.1: All cable types currently and commonly used in building practice in Europe except non-sheathed cables (wires), tied bundles and waveguides; optical fibre cables are covered.